



# User Guide

---

## VIGI App

---

# About This Guide

This User Guide provides information for centrally managing VIGI devices via TP-Link VIGI app. Detailed instructions on how to install the device can be found in the product's Quick Start Guide.

## Conventions

When using this guide, notice that:

- Features available of VIGI devices may vary due to your region, device model, firmware version, and app version. All images, steps, and descriptions in this guide are only examples and may not reflect your actual experience.
- The information in this document is subject to change without notice. Every effort has been made in the preparation of this document to ensure accuracy of the contents, but all statements, information, and recommendations in this document do not constitute the warranty of any kind, express or implied. Users must take full responsibility for their application of any products.
- This guide uses the specific formats to highlight special messages. The following table lists the conventions that are used throughout this guide.

<u>Underlined</u>	Indicates hyperlinks. You can click to redirect to a website or a specific section.
<b>Bold</b>	Indicates contents to be emphasized and texts on the web page, including the menus, tabs, buttons and so on.
>	The menu structures to show the path to load the corresponding page.
 <b>Caution</b>	Reminds you to be cautious, and Ignoring this type of note might result in device damage or data loss.
<b>Note</b>	Indicates information that helps you make better use of your device.

## More Information

- The latest firmware can be found at Download Center at <https://www.tp-link.com/support>.
- Product specifications can be found on the product page at <https://www.tp-link.com>.
- For technical support, the latest version of the Quick Installation Guide, User Guide and other information, please visit <https://www.tp-link.com/support>.
- To ask questions, find answers, and communicate with TP-Link users or engineers, please visit <https://community.tp-link.com> to join TP-Link Community.

# Contents

<b>About This Guide .....</b>	<b>II</b>
<b>Set Up Your VIGI Device .....</b>	<b>1</b>
1.1 Hardware Connection .....	2
1.1.1 For wired cameras and NVRs:.....	2
1.1.2 For Wi-Fi cameras: .....	2
1.1.3 For 4G cameras:.....	3
1.1.4 For solar panels: .....	3
1.2 Add Your VIGI Device via the VIGI app.....	3
1.2.1 Add Device Locally .....	3
1.2.2 Add Device Remotely.....	5
1.3 Add Your VIGI Camera to NVR via the VIGI app.....	8
<b>Main Device Controls .....</b>	<b>11</b>
<b>View Your Camera .....</b>	<b>14</b>
3.1 Live View .....	15
3.2 Notifications.....	16
3.3 Device Control .....	17
<b>Configure Solar Power Supply System .....</b>	<b>19</b>
3.1 Check Power Supply Statistics .....	20
3.2 Custom Power Supply Time .....	21
3.3 Restart Load Interface .....	22
<b>Configure Recording (Only for certain cameras) .....</b>	<b>23</b>
4.1 Format Micro SD Card .....	24
4.2 Configure Recording Schedule .....	24
<b>Alarm and Detection .....</b>	<b>26</b>
5.1 Alarm (Only for certain cameras) .....	27
5.2 Human Detection.....	27
5.3 Vehicle Detection .....	27
5.4 Motion Detection .....	28
5.5 Camera Tampering .....	28
5.6 Line Crossing Detection .....	29

5.7	Intrusion Detection .....	29
5.8	Region Entering Detection .....	30
5.9	Region Exiting Detection .....	30
5.10	Object Abandoned/Removal Detection.....	31

**Device Settings.....32**

6.1	Device Information.....	33
6.2	Change Device Password .....	33
6.3	Reboot Schedule .....	34
6.4	Device Sharing.....	34
6.5	Data Limit (For 4G cameras) .....	35
6.6	Other Features.....	35



# ***Set Up Your VIGI Device***

This chapter guides you on how to add your VIGI device to the network via the. This chapter includes the following sections:

- [Hardware Connection](#)
- [Add Your VIGI Device via the VIGI app](#)
- [Add Your VIGI Camera to NVR via the VIGI app](#)

## ♥ 1.1 Hardware Connection

### 1.1.1 For wired cameras and NVRs:

Connect the VIGI cameras and NVRs to the network according to the figure below.

**Note:** Here we use a VIGI NVR (Network Video Recorder) and a TP-Link Switch as examples.

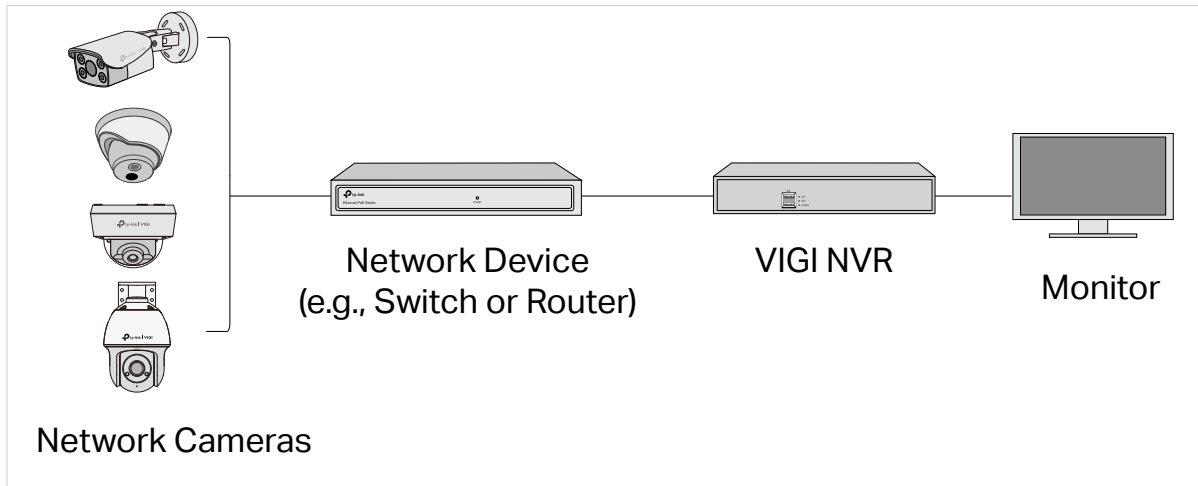

### 1.1.2 For Wi-Fi cameras:

Here is a typical network topology. The camera works with an NVR for easier batch access and management.

**Note:** Here we use a VIGI NVR (Network Video Recorder) and a TP-Link Switch as examples.

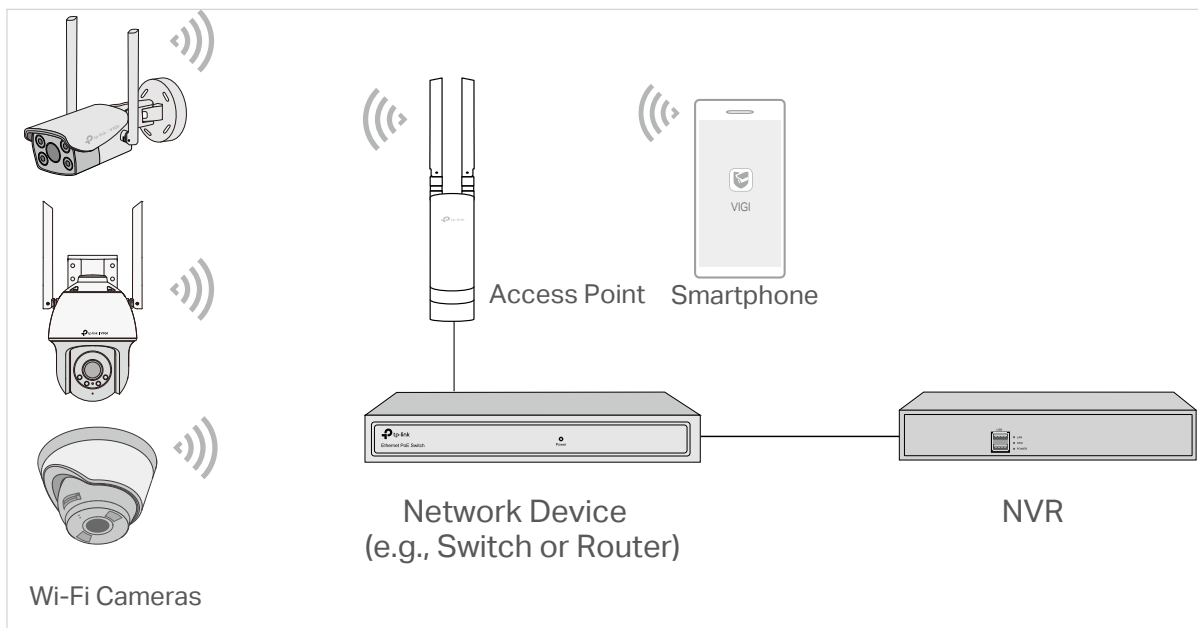

### 1. 1. 3 For 4G cameras:

Here is a typical network topology for 4G network camera. You need insert a Nano SIM card into the SIM card slot. If you want to manage the camera locally, you can connect the camera to your network via an Ethernet cable.

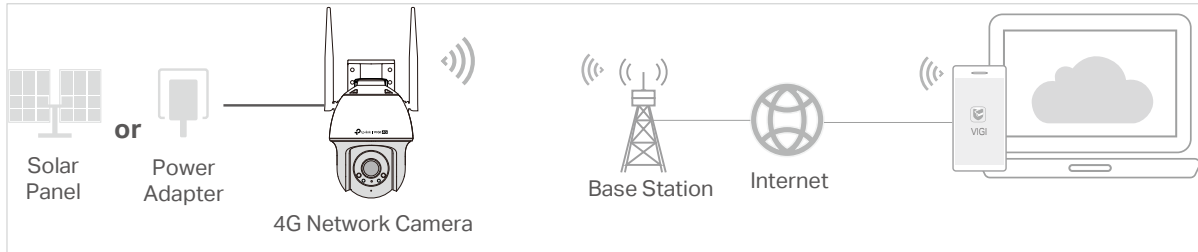

### 1. 1. 4 For solar panels:

Here is a typical network topology for the solar panel.

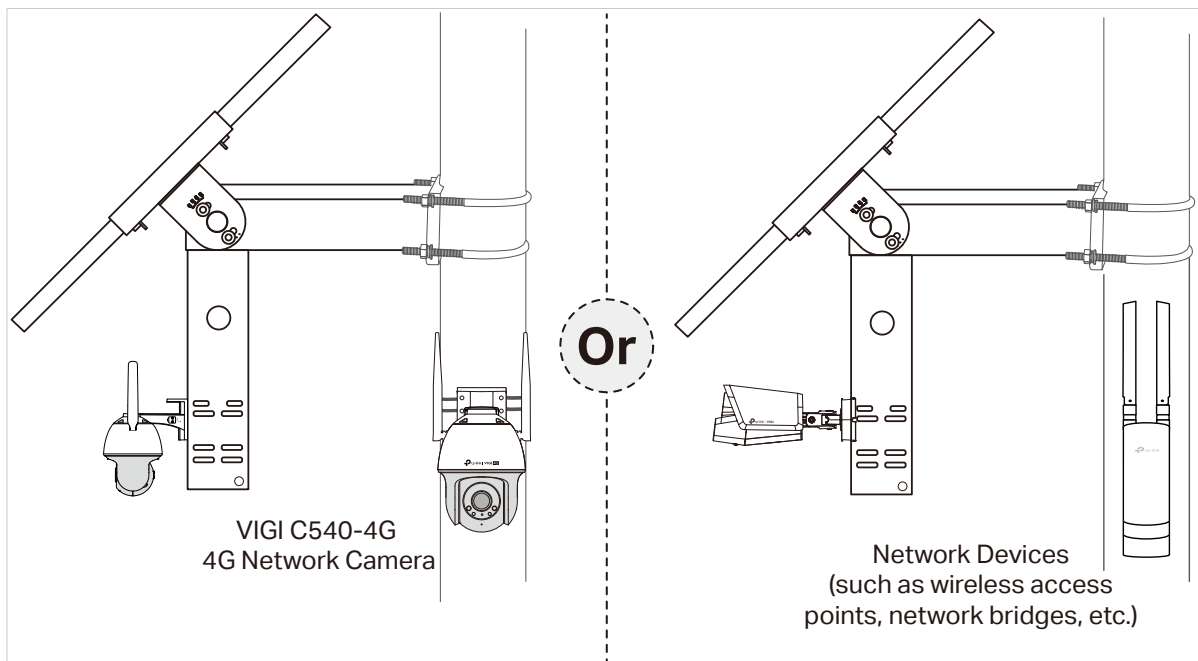

## ♥ 1. 2 Add Your VIGI Device via the VIGI app

Note: More management methods such as using VIGI security manager and a web browser are supported. For more instructions, see the Quick Start Guide included in the package.

The VIGI app is an application for mobile devices. With the VIGI app, you can remotely view live video, manage VIGI devices, and get instant alerts.

### 1. 2. 1 Add Device Locally

To add your VIGI devices successfully, ensure that your VIGI devices are in the same subnet as your phone. In this section we use a VIGI camera as an example.

1. Download and install the **VIGI** app from the Apple App Store or Google Play.



2. Open the **VIGI** app, tap the **+** button on the top right and scan the QR code on your camera. You can find the QR code printed on your product label of your camera.

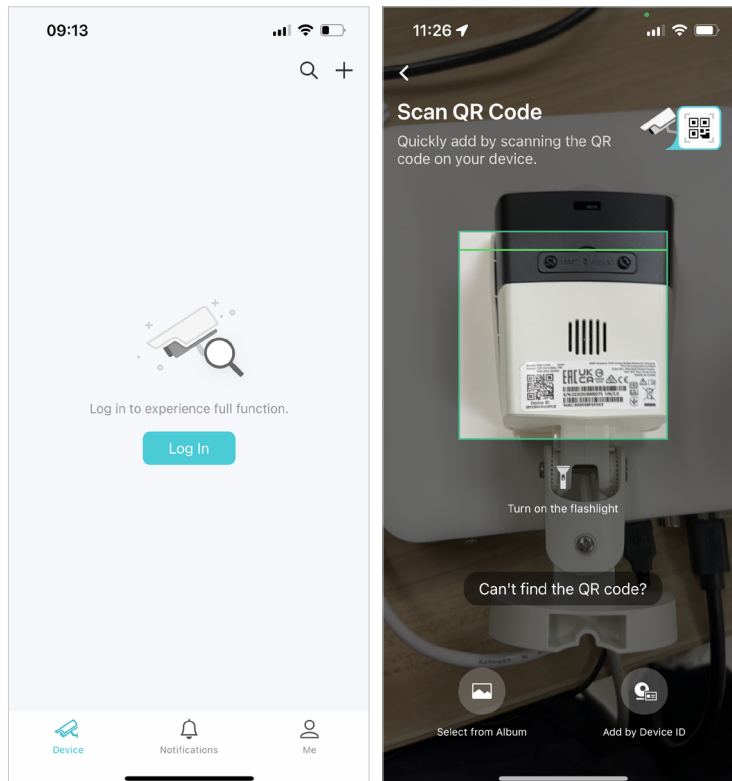



3. The system will auto search the cameras in the same network, select the desired cameras, and follow the app instructions to add your cameras.

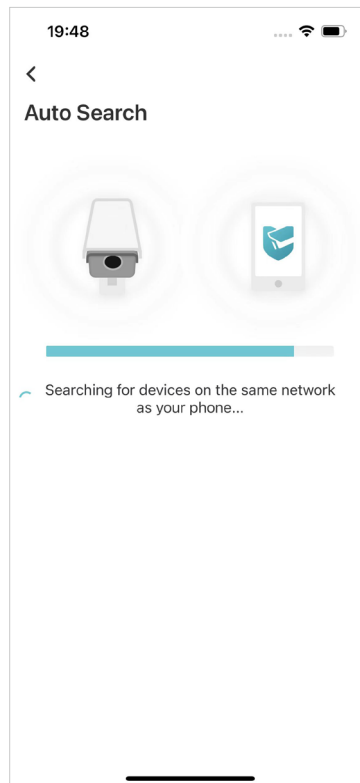

### 1. 2. 2 Add Device Remotely

To add your VIGI devices successfully, ensure that your VIGI devices are connected to the internet. In this section we use a VIGI camera as an example.

1. Download and install the **VIGI** app from the Apple App Store or Google Play.



2. Open the **VIGI** app and log in with your TP-Link ID. If you don't have an account, you can sign up first.

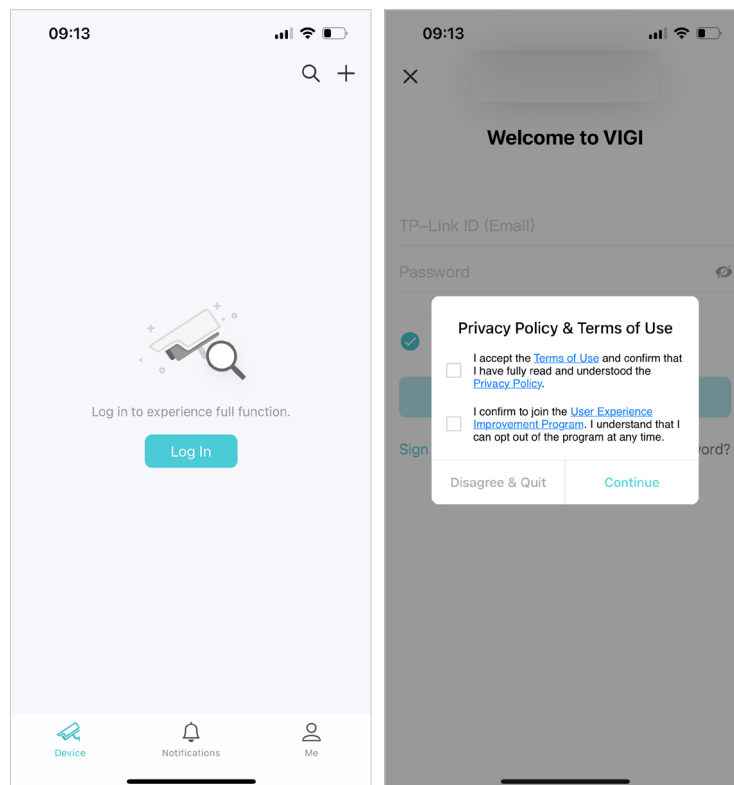

3. Tap the **+** button on the top right and scan the QR code on your camera. You can find the QR code printed on your product label of your camera.



## 4. Follow the app instructions and set a device password to activate the device.

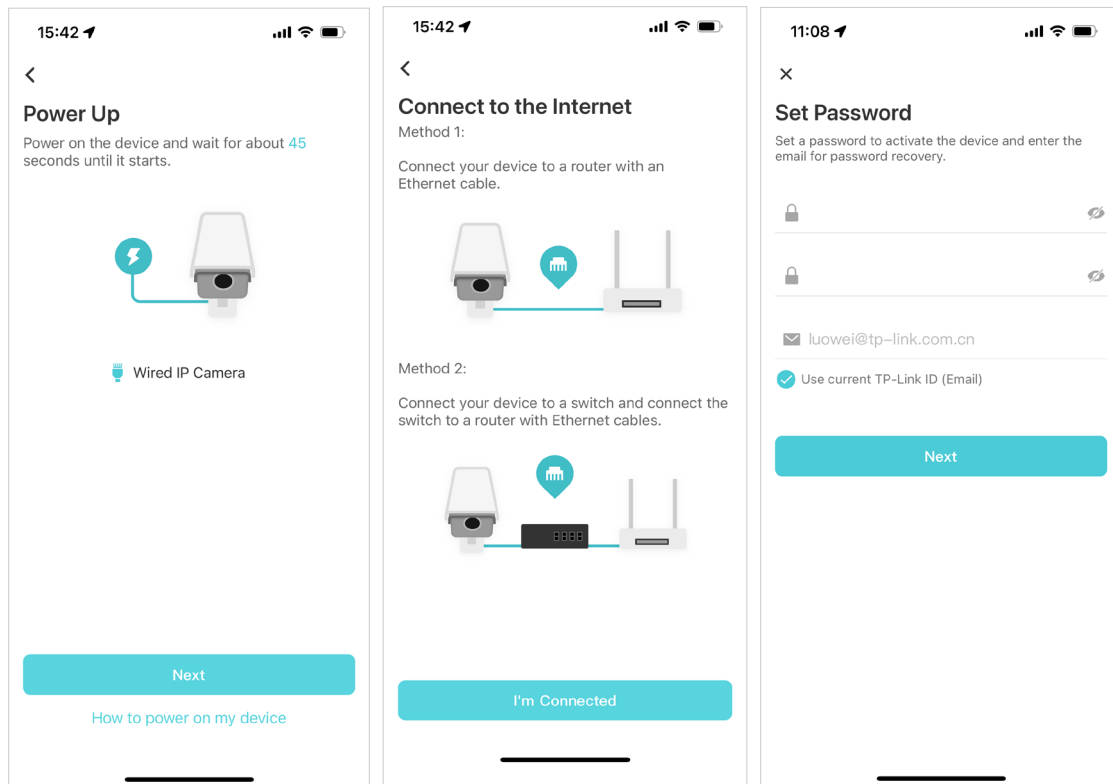

## 5. Set the time zone, and give a name to your device.

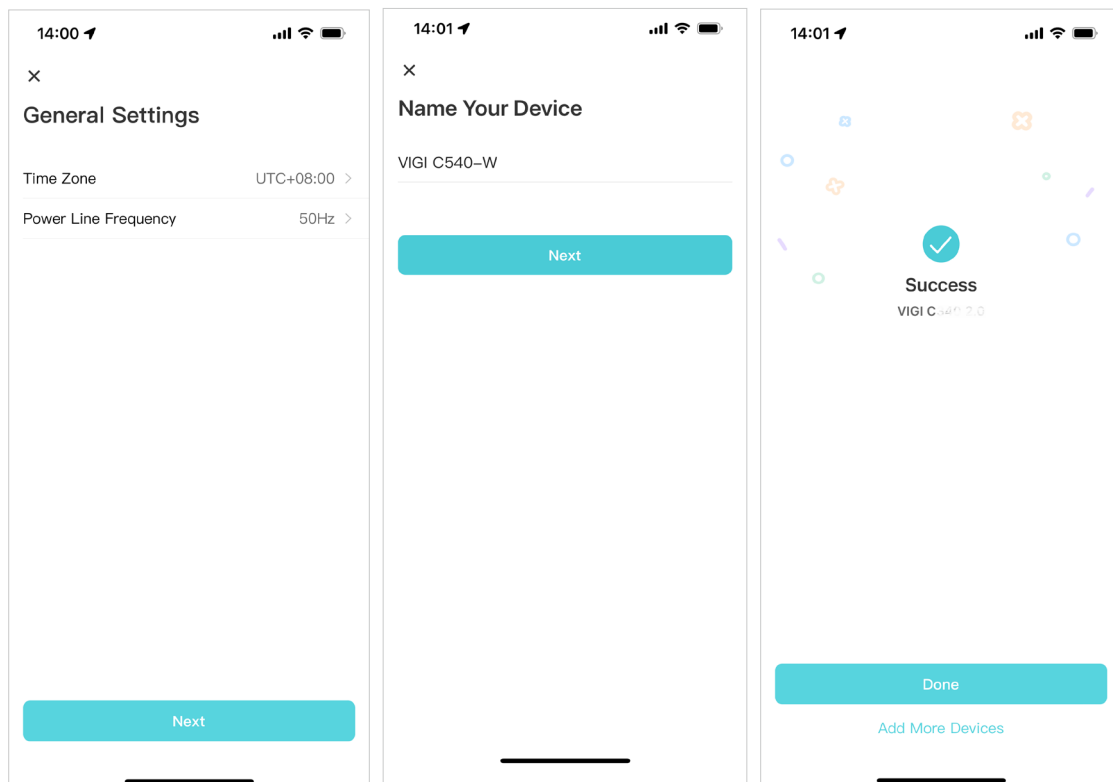

6. Tap **Done** to finish the setup, and now you can view and manage the camera.

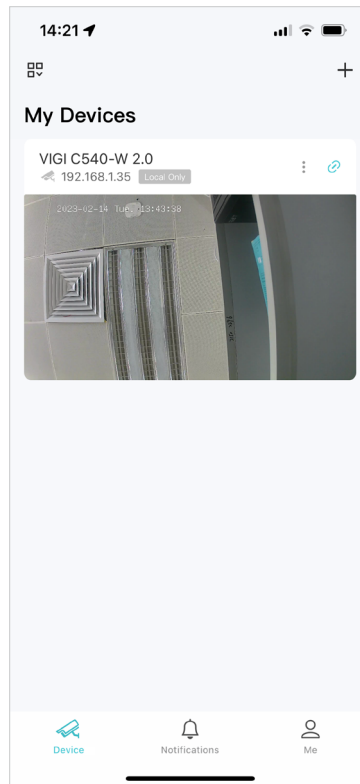

Note: Quickly add by entering the Device ID printed on your product label of your camera. Make sure your camera has the internet connection.



## ♥ 1.3 Add Your VIGI Camera to NVR via the VIGI app

After setting up the NVR using the VIGI app, you can quickly add you VIGI camera to the NVR using the VIGI app too. Follow the steps below to add your VIGI cameras to the NVR:

1. Go to the **My Devices** page, tap the  icon.

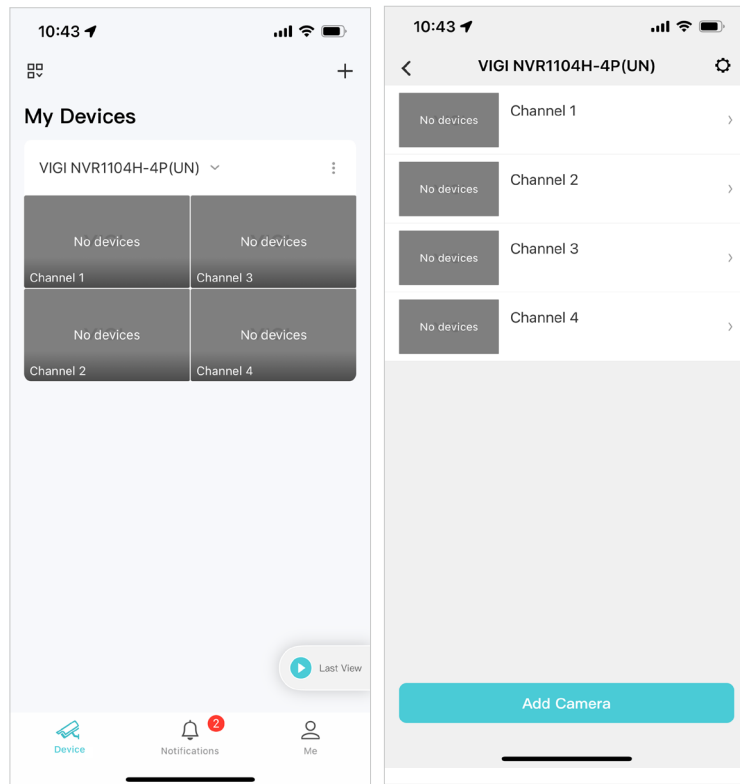

2. Tap **Add Camera**, then follow the app instructions to add the camera.

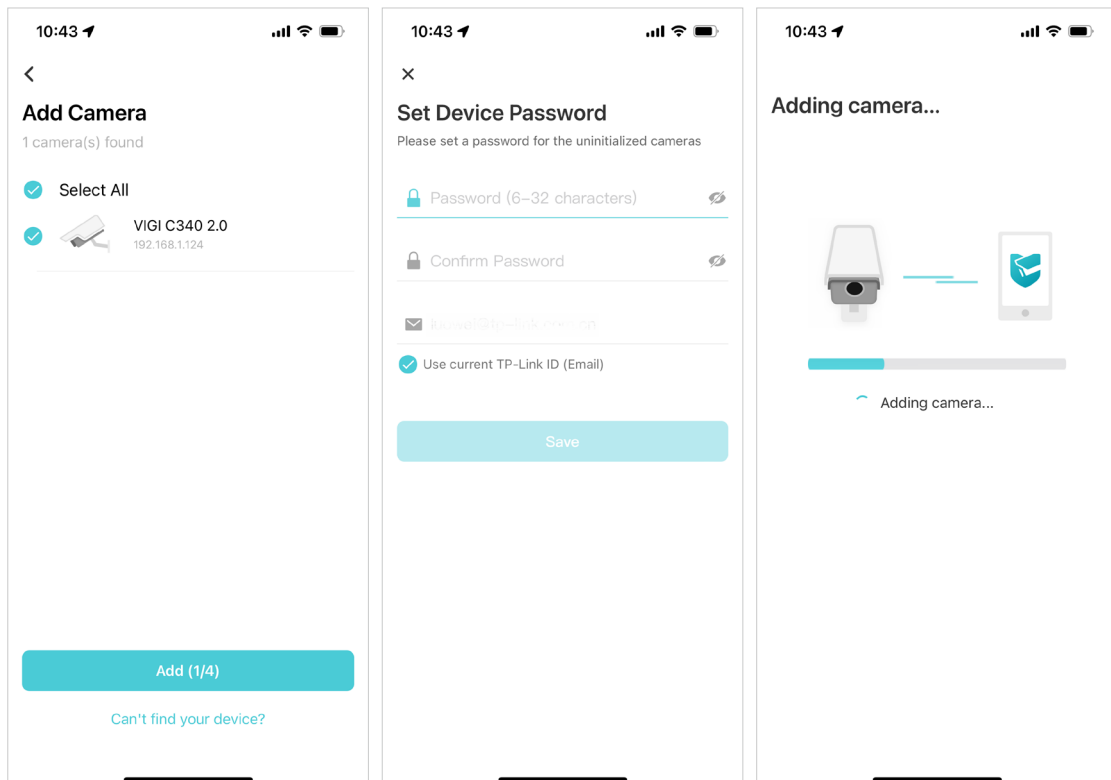

3. Tap **Complete**, then you can see that your camera has been added to the NVR, and you can view live video on the NVR's channel.

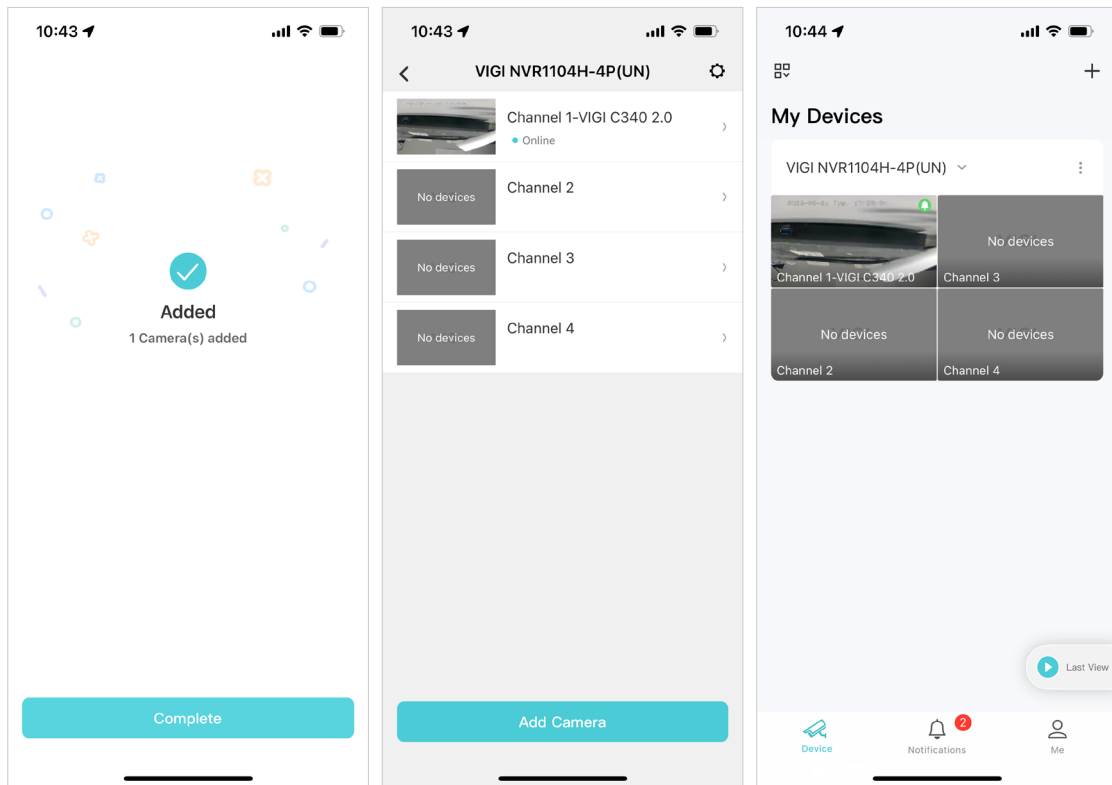



## ***Main Device Controls***

After you successfully set up your camera, you will see the home page of the VIGI app.

Here you can view and manage all devices that you've added to VIGI. Tap your camera to enter the live view page and further manage it.

### ■ Device

This page lists all your devices you've added and you can view them directly and manage them easily. You can tap on the camera card enter the Live View page, tap the gear icon to enter the Device Settings page.

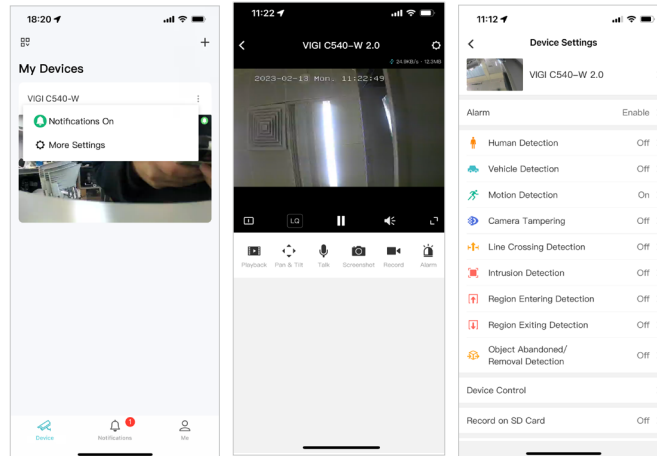

### ■ Notifications

This page lists the notifications you receive when your camera detects an event. To set the notification type, refer to the [Notifications](#) section.

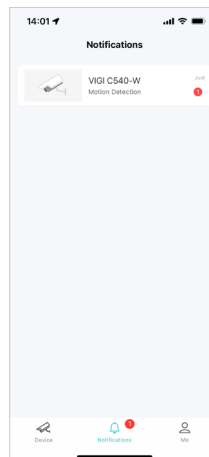



## ■ Me

On this page, you can change the account settings, check the memorable moments you saved, or find the FAQs and other useful features.

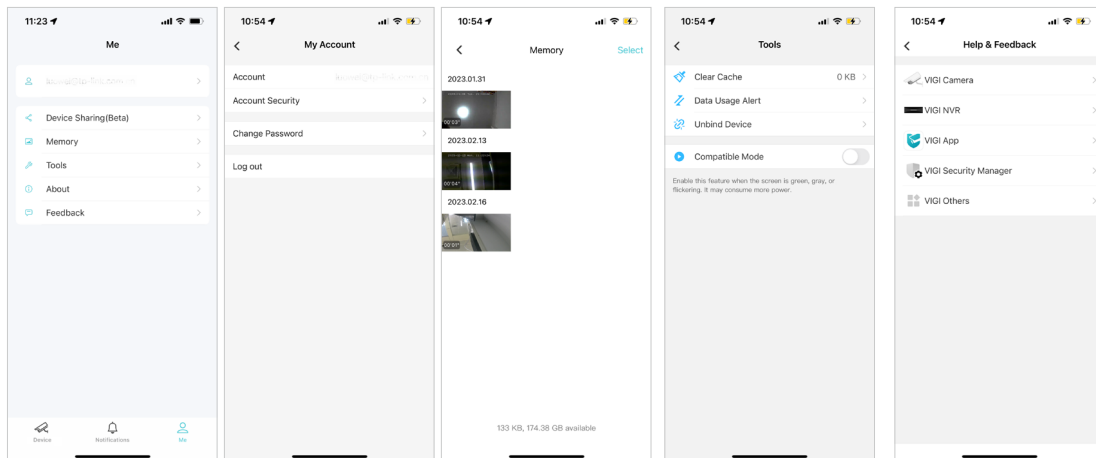

# 3

## *View Your Camera*

After setting up your cameras, you can view your cameras via the VIGI app. This chapter includes the following sections:

- [Live View](#)
- [Notifications](#)
- [Device Control](#)

## ♥ 3.1 Live View

After you successfully add your camera, you will see your camera listed on the My Devices page. Bind it to your TP-Link ID, and you can view and manage your camera from anywhere at any time with the VIGI app.

### ■ Devices

This page lists all your devices you've added and you can view them directly and manage them easily. You can tap on the camera card enter the Live View page.

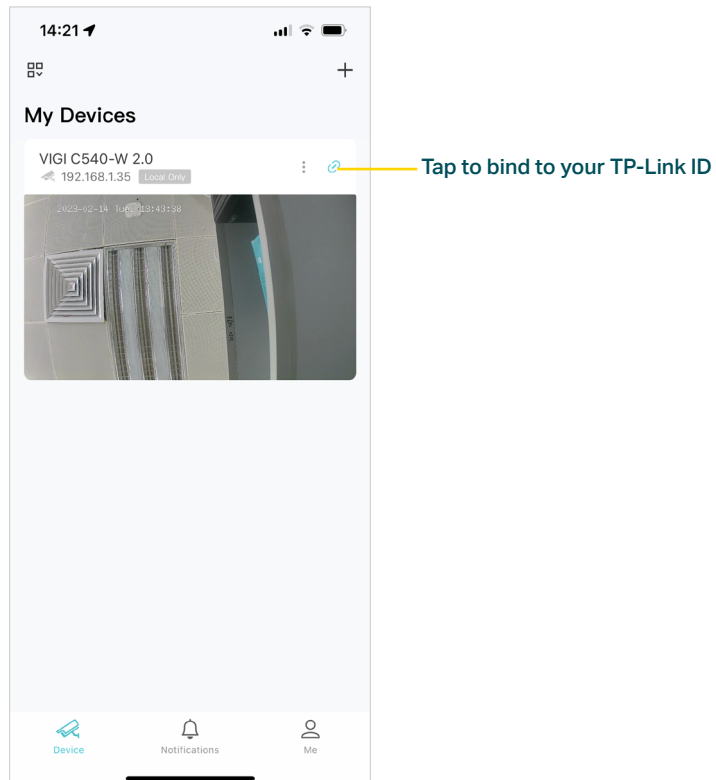

## ■ Live View

On the Live View page, you can keep an eye on what's important to you real-time from anywhere with the VIGI app.

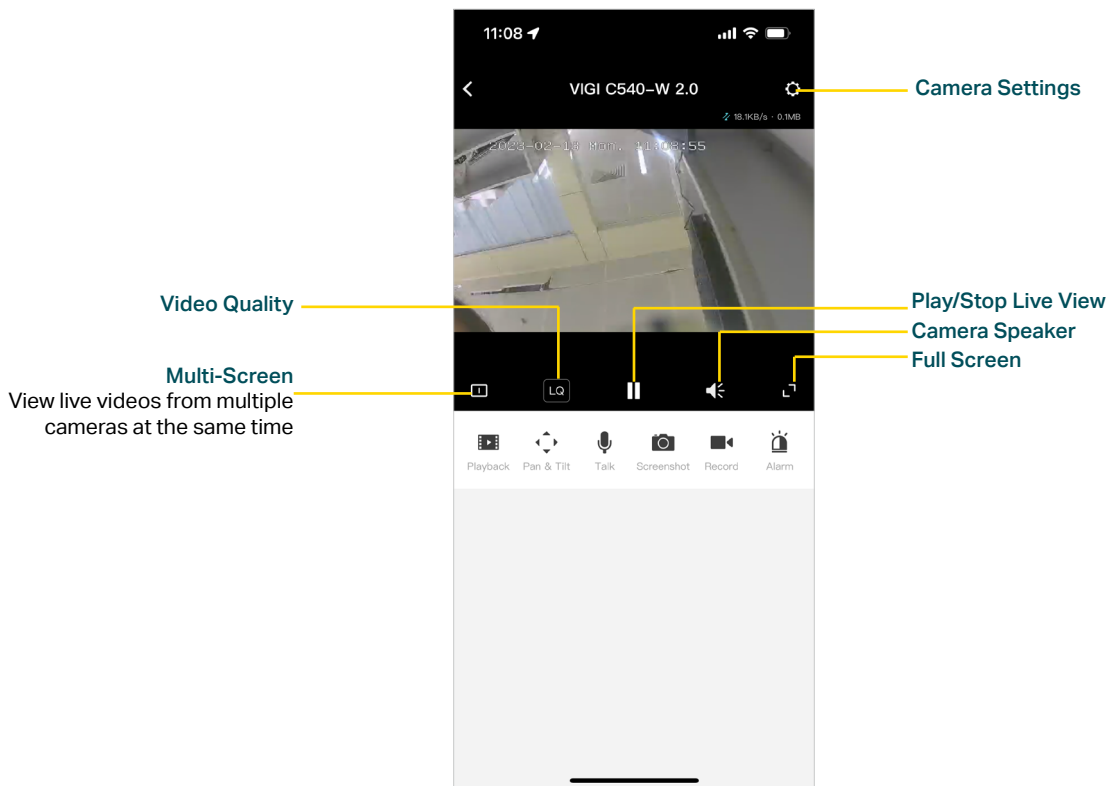

Playback

Tap to play back the recordings.



Pan & Tilt

(Only for Pan & Tilt cameras) Tap to control the pan & tilt of the camera.



Talk

(Only for certain cameras) Tap to talk (two-way audio).



Screenshot

Tap to capture screenshots.



Record

Tap to start recording.



Alarm

(Only for certain cameras) Click to adjust the volume of the speaker.

## ♥ 3.2 Notifications

Get automatic notifications when your camera detects an event. Tap [Notifications](#), you can check all events here. To set the notification type, tap [More Settings](#) on the [My Devices](#) page or tap the gear icon on the [Live View](#) page to enter the [Device Settings](#) page, then tap [Notifications](#).

Note: Make sure you have turned on the detection and notification features to receive notifications.

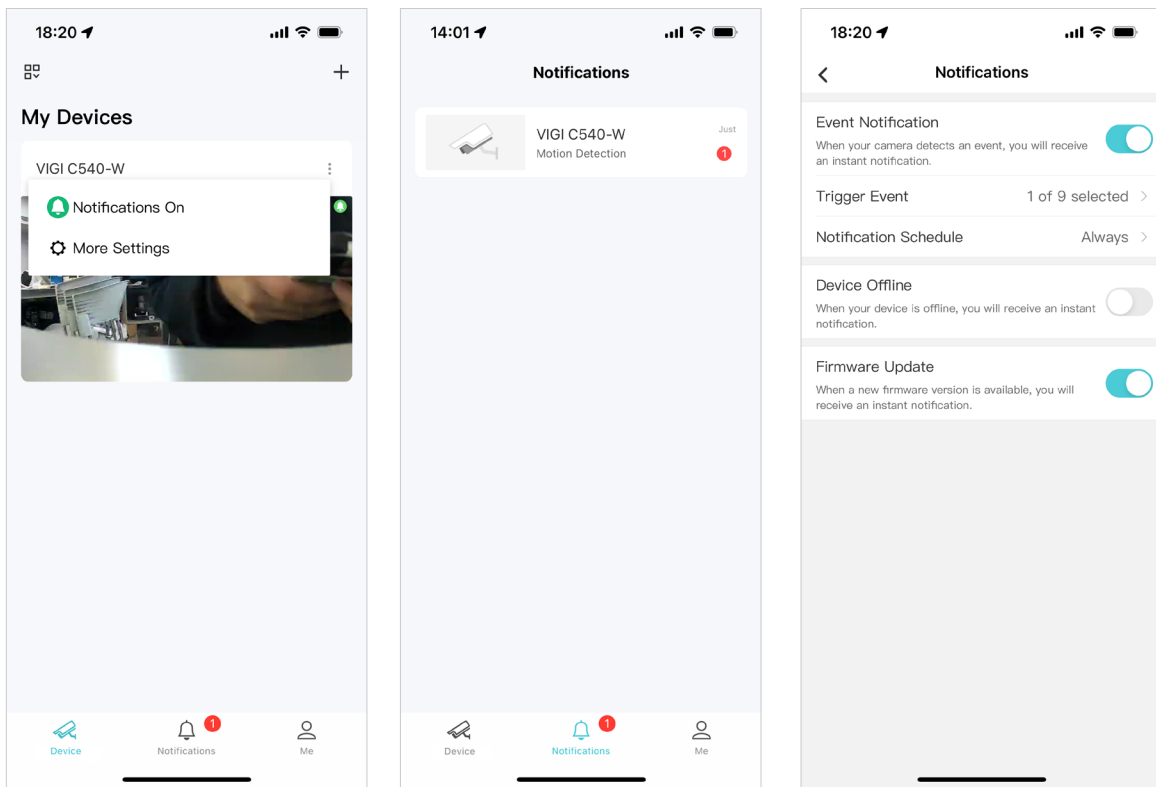

### ♥ 3.3 Device Control

You can adjust the live view display on the Device Control page. You can tap [More Settings](#) on the [My Devices](#) page or tap the gear icon on the [Live View](#) page to enter the [Device Settings](#) page. On the Device Control page, you can change the camera settings of your camera to meet various needs.

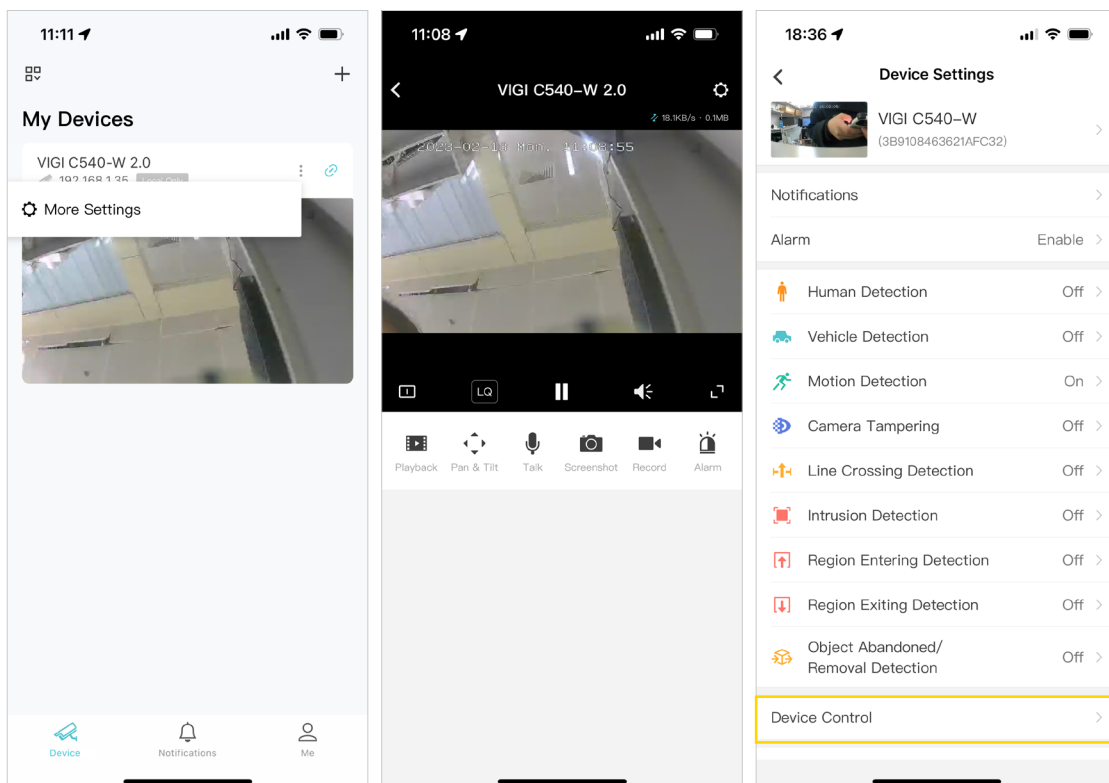

Follow the app instructions to configure the settings. You can enable HLC, set LED status, change the video direction, configure WDR, disable the microphone or adjust the microphone volume (for certain cameras), adjust the speaker/alarm volume (for certain cameras), set the night vision and light brightness (for certain cameras).

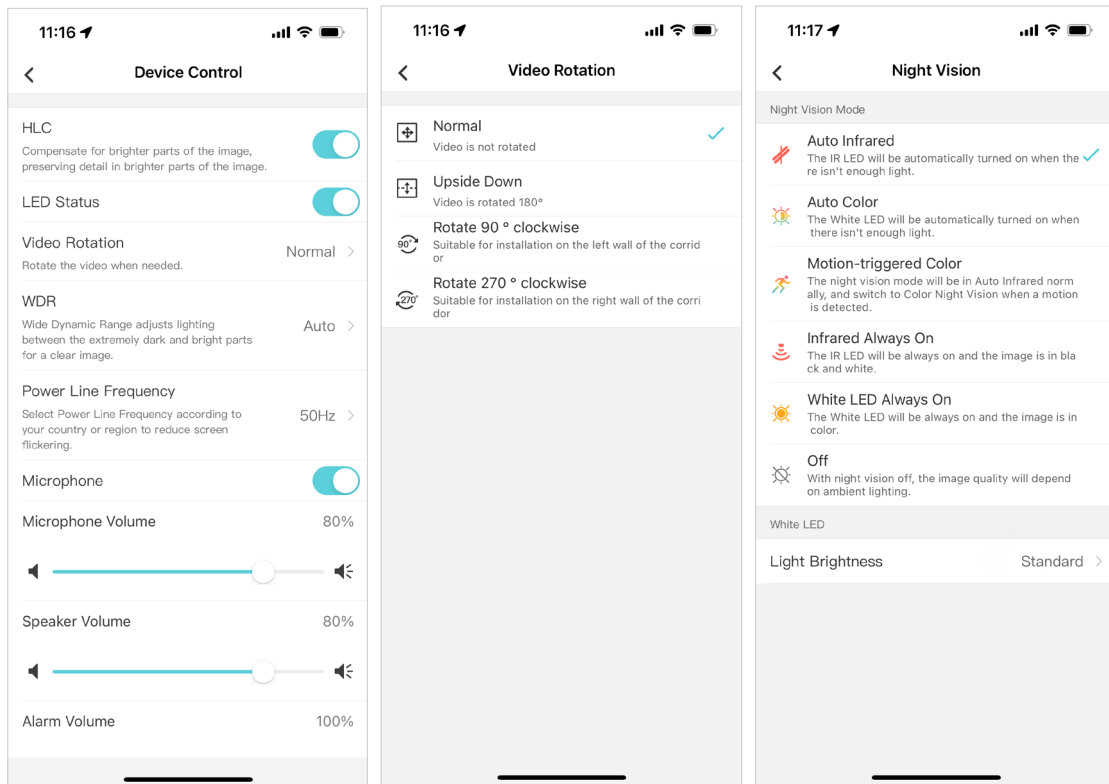

# 3

## ***Configure Solar Power Supply System***

After setting up your VIGI solar power supply system, you can check the solar power supply statistics and set the power supply time and restart the load interface via the VIGI app. This chapter includes the following sections:

- [Check Power Supply Statistics](#)
- [Custom Power Supply Time](#)
- [Restart Load Interface](#)

### ♥ 3.1 Check Power Supply Statistics

Go to Devices, tap on the solar panel card to enter device page. Here you can check the device power supply details. Tap Power Statistics to view more details.

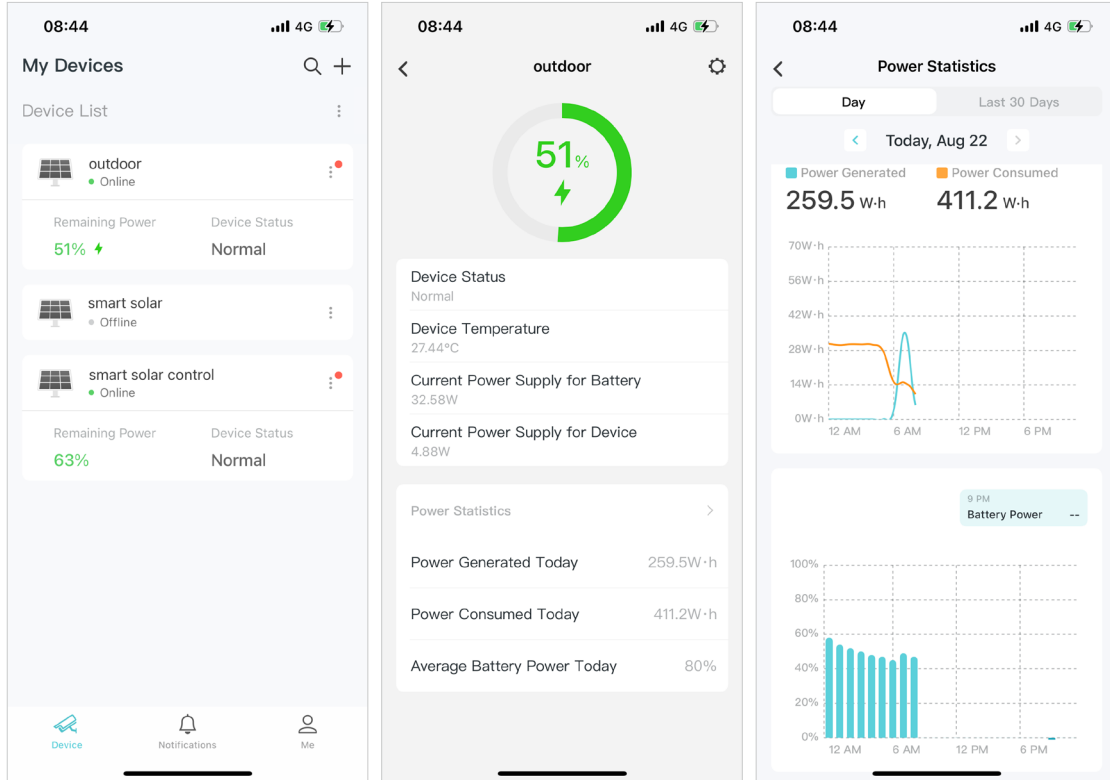



## ♥ 3.2 Custom Power Supply Time

Go to Devices, tap on the solar panel card to enter device page, tap the gear icon to enter Device Settings page. Here you can set when to supply power to the device for each load interface, all day or the specific period.

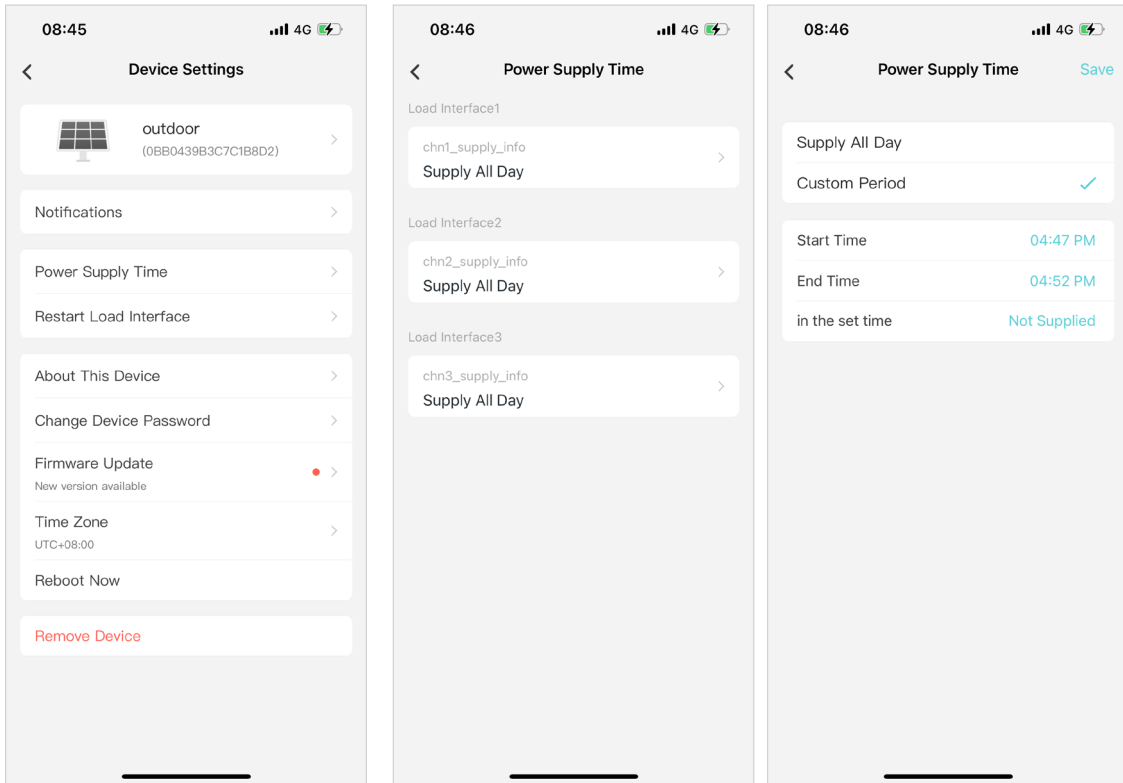

### ♥ 3.3 Restart Load Interface

Go to Devices, tap on the solar panel card to enter device page, tap the gear icon to enter Device Settings page. Here you can tap Restart to restart the desired load interface.

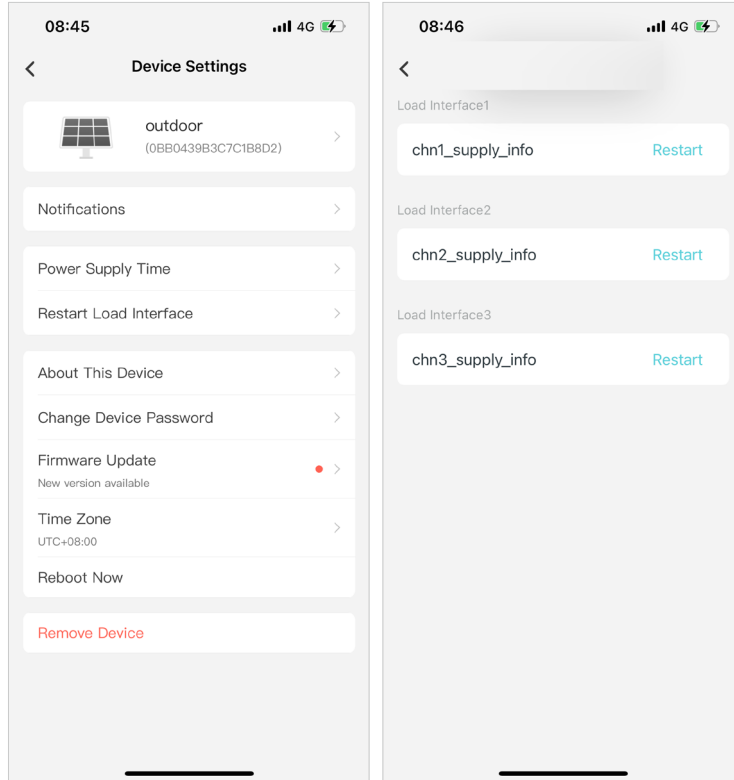

# 4

## ***Configure Recording (Only for certain cameras)***

VIGI cameras support both motion recordings and continuous recordings, and also customized recording schedules. And recordings can be saved into a micro SD card. This chapter includes the following sections:

- [Format Micro SD Card](#)
- [Configure Recording Schedule](#)

## ♥ 4.1 Format Micro SD Card

To use the recording feature, you need to insert a micro SD card into the camera's SD card slot and follow the app instructions to format the card for recording.

You can tap [More Settings](#) on the [My Devices](#) page or tap the gear icon on the [Live View](#) page to enter the [Device Settings](#) page. Tap [Record on SD Card](#), tap [Format](#) to format the SD card. You can also enable [Loop Recording](#), then new recordings will overwrite previous recordings when storage is not enough.

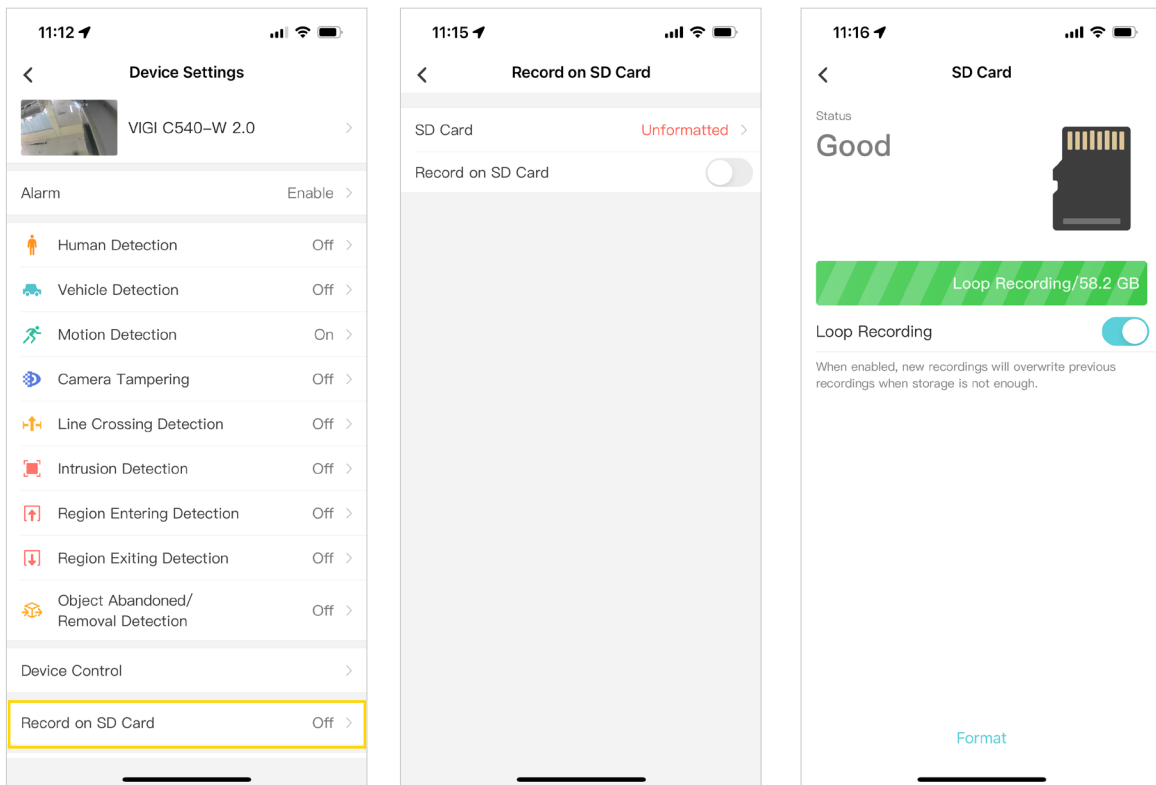

## ♥ 4.2 Configure Recording Schedule

Recording schedule section provides convenience and flexibility for the daily monitoring of your camera. You can choose to set motion recordings, continuous recordings, or customize the recording schedule at a time. You can set different schedules for each day.

You can tap **More Settings** on the **My Devices** page or tap the gear icon on the **Live View** page to enter the **Device Settings** page. Tap **Record on SD Card**, tap **Record on Schedule**.

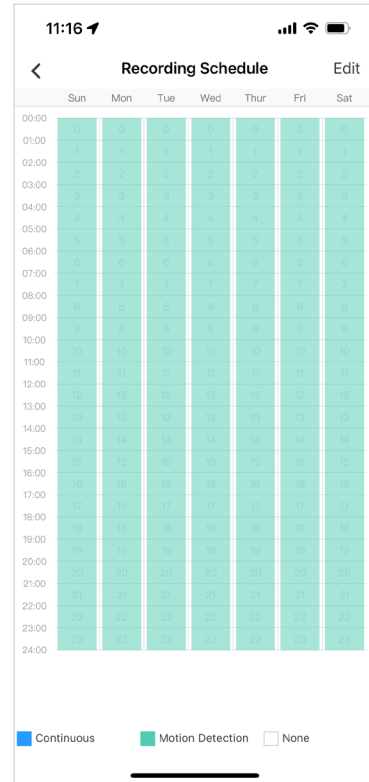
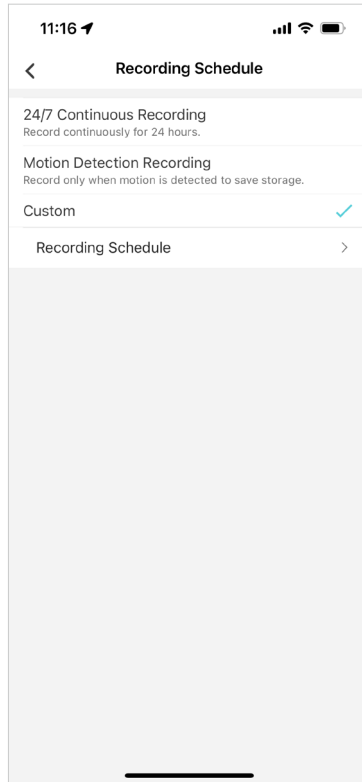
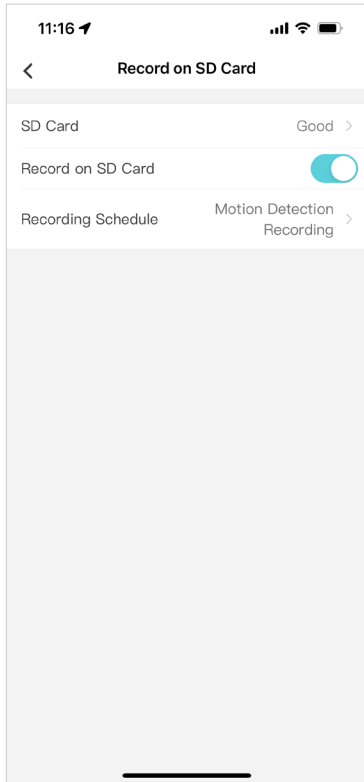

# 5

## ***Alarm and Detection***

This chapter guides you on how to configure the event settings and alarm actions when your cameras detect different types of events. This chapter includes the following sections:

- [Alarm \(Only for certain cameras\)](#)
- [Human Detection](#)
- [Vehicle Detection](#)
- [Motion Detection](#)
- [Camera Tampering](#)
- [Line Crossing Detection](#)
- [Intrusion Detection](#)
- [Region Entering Detection](#)
- [Region Exiting Detection](#)
- [Object Abandoned/Removal Detection](#)

## ♥ 5.1 Alarm (Only for certain cameras)

When Alarm is enabled, the VIGI app will alert you of activity that matters and sends notifications straight to you when activities detected. You can customize the alarm type (sound alarm or light alarm), alarm schedule as needed.

Tap [More Settings](#) on the [My Devices](#) page or tap the gear icon on the [Live View](#) page to enter the [Device Settings](#) page. Tap [Alarm](#), you can change the alarm settings of your camera to meet various needs.

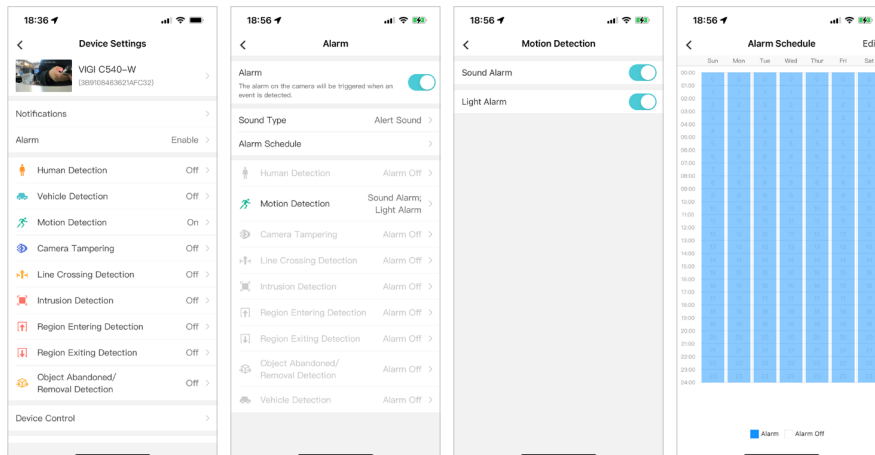

## ♥ 5.2 Human Detection

Human detection triggers alarm actions when cameras detect persons are moving in the specified areas. You can customize the area settings, select the triggered actions and set the alarm schedule.

Tap [More Settings](#) on the [My Devices](#) page or tap the gear icon on the [Live View](#) page to enter the [Device Settings](#) page. Tap [Human Detection](#) to start detection settings.

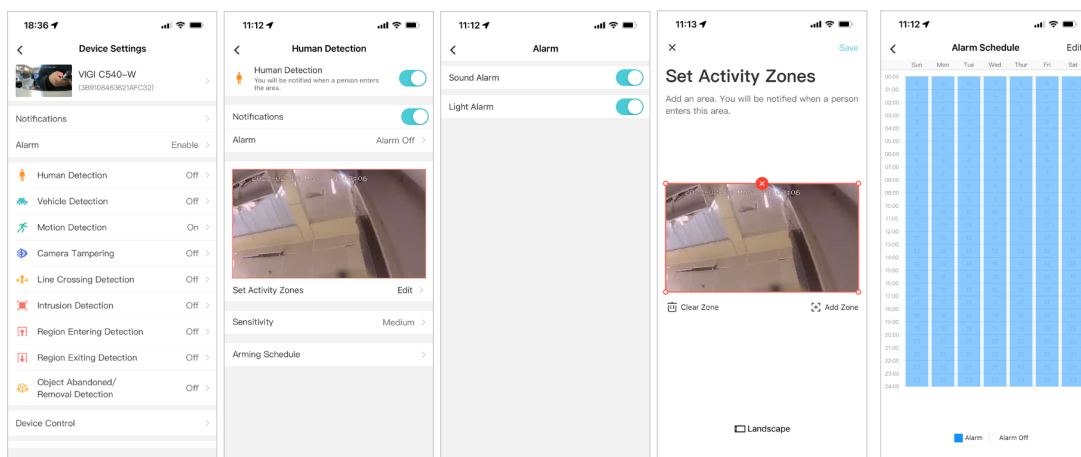

## ♥ 5.3 Vehicle Detection

Vehicle detection triggers alarm actions when cameras detect vehicles are moving in the specified areas. You can customize the area settings, select the triggered actions and set the alarm schedule.

Tap **More Settings** on the **My Devices** page or tap the gear icon on the **Live View** page to enter the **Device Settings** page. Tap **Vehicle Detection** to start detection settings.

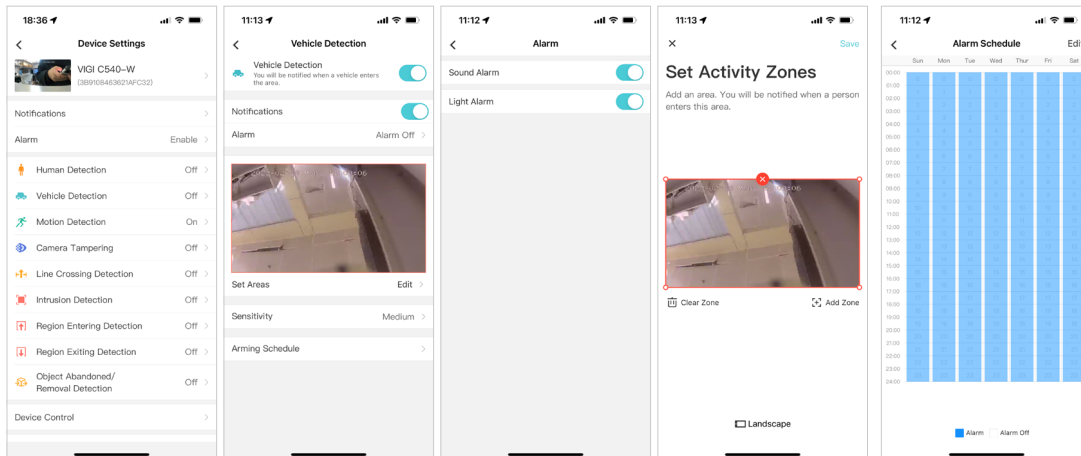

## ♥ 5.4 Motion Detection

Motion detection allows cameras to detect the moving objects in the monitored area and triggers alarm actions. You can customize the object classification, area settings, select the triggered actions and set the alarm schedule.

Tap **More Settings** on the **My Devices** page or tap the gear icon on the **Live View** page to enter the **Device Settings** page. Tap **Motion Detection** to start detection settings.

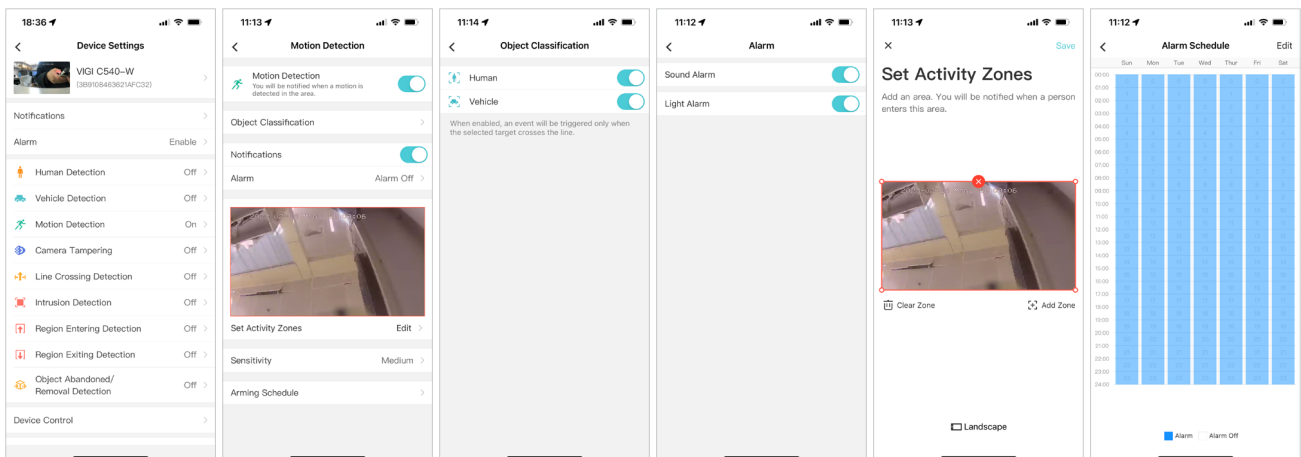

## ♥ 5.5 Camera Tampering

Camera tampering triggers alarm actions when an area of camera's lens is purposely blocked, obstructed or vandalized. You can customize the video tampering settings, enable notifications, select the triggered actions.



Tap **More Settings** on the **My Devices** page or tap the gear icon on the **Live View** page to enter the **Device Settings** page. Tap **Camera Tampering** to start the settings.

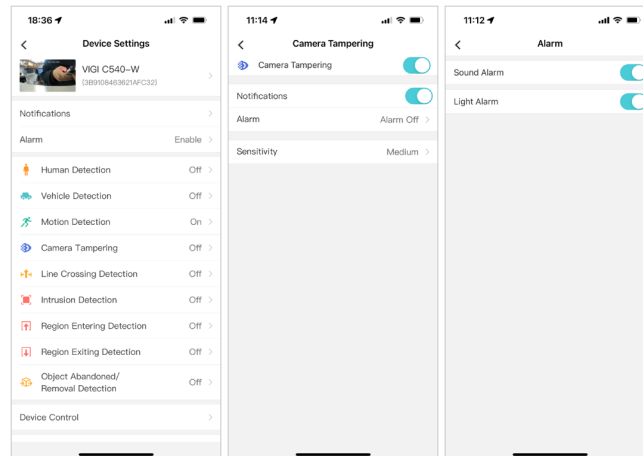

## ♥ 5.6 Line Crossing Detection

Line crossing detection triggers alarm actions when cameras detect that moving objects cross a customized virtual line. You can customize the object classification, the line crossing detection settings, select the triggered actions and set the alarm schedule.

Tap **More Settings** on the **My Devices** page or tap the gear icon on the **Live View** page to enter the **Device Settings** page. Tap **Line Crossing Detection** to start detection settings.

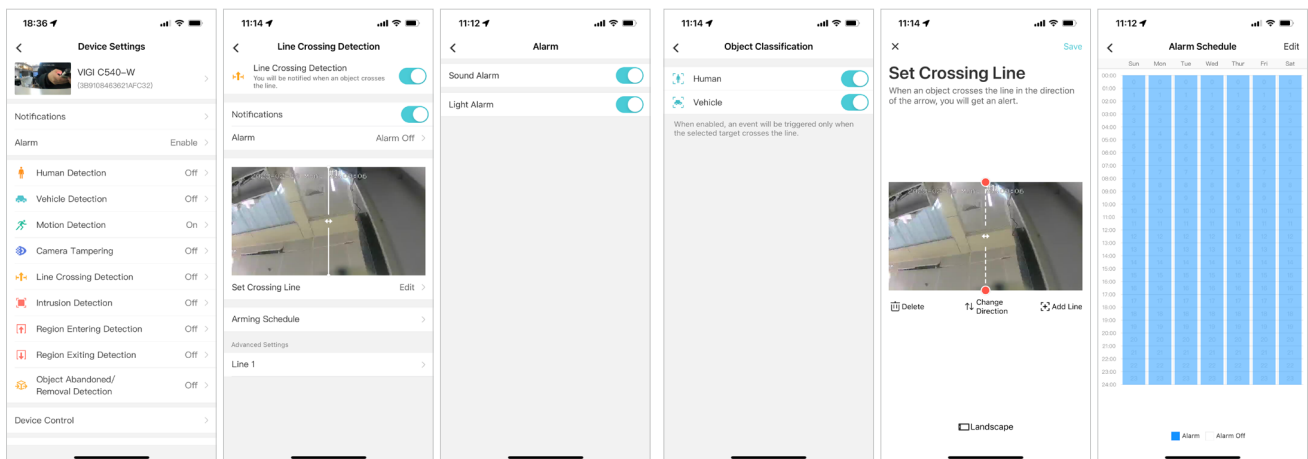

## ♥ 5.7 Intrusion Detection

Intrusion detection triggers alarm actions when cameras detect an intrusion in the specified areas. You can customize the intrusion detection settings, select the triggered actions and set the alarm schedule.

Tap **More Settings** on the **My Devices** page or tap the gear icon on the **Live View** page to enter the **Device Settings** page. Tap **Intrusion Detection** to start detection settings. In the **Advanced Settings** section, you can set the object classification, intrusion time, percentage and sensitivity.

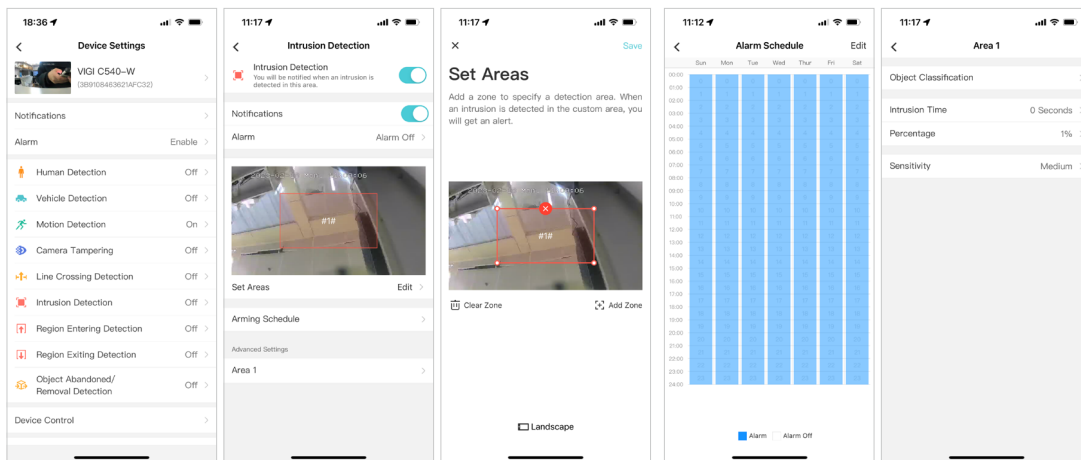

## ♥ 5.8 Region Entering Detection

Region entering detection triggers alarm actions when cameras detect moving objects enter the specified regions. You can customize the region settings, select the triggered actions and set the alarm schedule.

Tap **More Settings** on the **My Devices** page or tap the gear icon on the **Live View** page to enter the **Device Settings** page. Tap **Region Entering Detection** to start detection settings. In the **Advanced Settings** section, you can set the object classification and sensitivity.

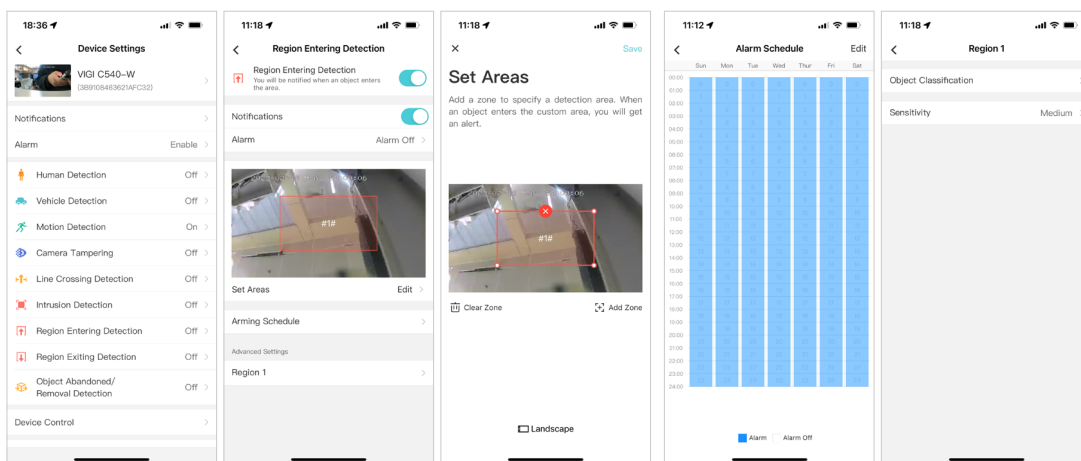

## ♥ 5.9 Region Exiting Detection

Region exiting detection triggers alarm actions when cameras detect moving objects exit the specified regions. You can customize the region settings, select the triggered actions and set the alarm schedule.

Tap **More Settings** on the **My Devices** page or tap the gear icon on the **Live View** page to enter the **Device Settings** page. Tap **Region Exiting Detection** to start detection settings. In the **Advanced Settings** section, you can set the object classification and sensitivity.

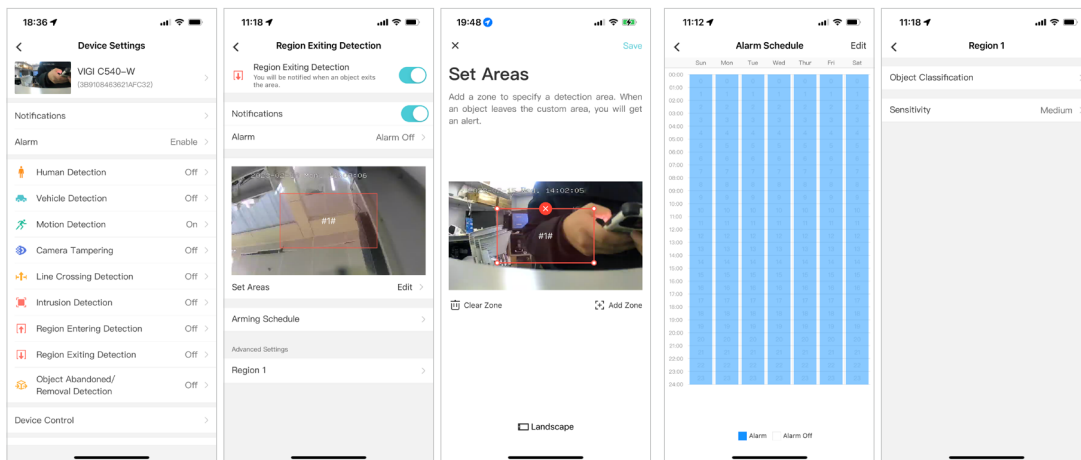

## ♥ 5.10 Object Abandoned/Removal Detection

Object abandoned/removal detection triggers alarm actions when cameras detect objects are left behind or taken away in the specified areas. You can customize the area settings, select the triggered actions and set the alarm schedule.

Tap **More Settings** on the **My Devices** page or tap the gear icon on the **Live View** page to enter the **Device Settings** page. Tap **Region Exiting Detection** to start detection settings. In the **Advanced Settings** section, you can set the object classification and sensitivity.

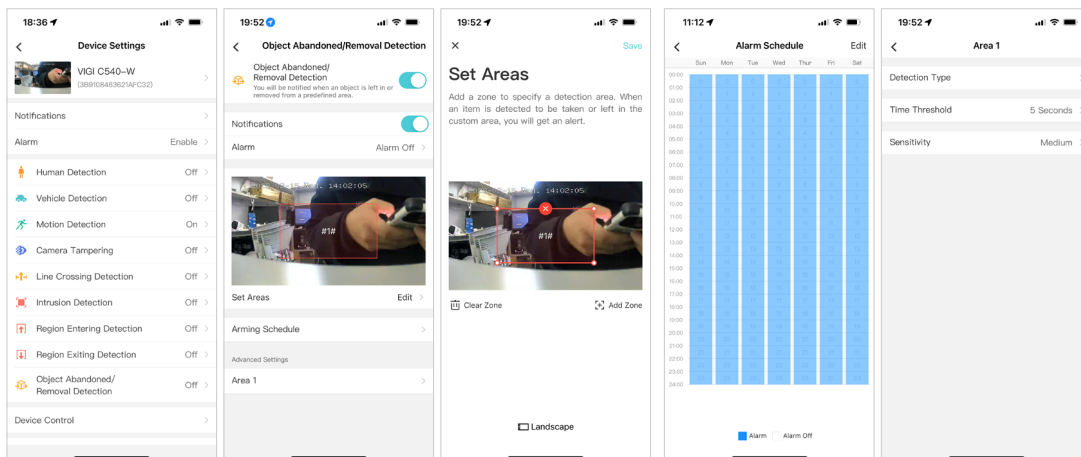

# 6

## ***Device Settings***

This chapter contains the following sections:

- [Device Information](#)
- [Change Device Password](#)
- [Reboot Schedule](#)
- [Device Sharing](#)
- [Data Limit \(For 4G cameras\)](#)
- [Other Features](#)

## ♥ 6.1 Device Information

You can tap [More Settings](#) on the [My Devices page](#) or tap the gear icon on the [Live View page](#) to enter the [Device Settings](#) page. Tap your device model to change its device name, tap [About This Device](#) to view the device information including its username, IP address and MAC address.

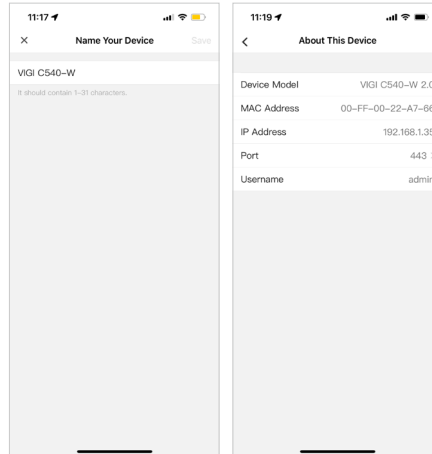

## ♥ 6.2 Change Device Password

You can tap [More Settings](#) on the [My Devices page](#) or tap the gear icon on the [Live View page](#) to enter the [Device Settings](#) page. Tap [Change Device Password](#) to change the device password which will be required when you log in to this device.

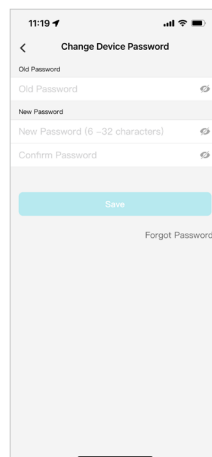

## 6.3 Reboot Schedule

You can tap [More Settings](#) on the [My Devices](#) page or tap the gear icon on the [Live View](#) page to enter the [Device Settings](#) page. Tap [Reboot Schedule](#) to reboot the device as needed. You can schedule the reboot regularly or tap the [Reboot Manually](#) to reboot the device immediately.

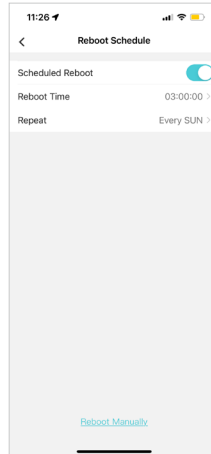

## 6.4 Device Sharing

You can tap [More Settings](#) on the [My Devices](#) page or tap the gear icon on the [Live View](#) page to enter the [Device Settings](#) page. Tap [Device Sharing](#) to share your device with your family members.

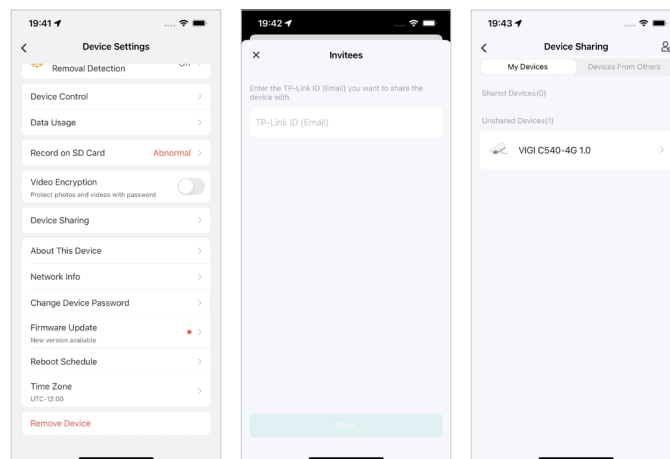

## ♥ 6.5 Data Limit (For 4G cameras)

You can tap [More Settings](#) on the [My Devices page](#) or tap the gear icon on the [Live View page](#) to enter the [Device Settings](#) page. Tap [Data Usage](#) to set the data limit and enable data usage alert.

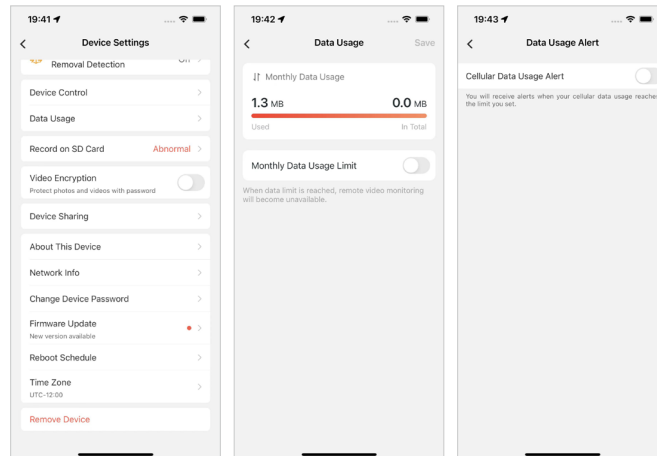

## ♥ 6.6 Other Features

You can tap [More Settings](#) on the [My Devices page](#) or tap the gear icon on the [Live View page](#) to enter the [Device Settings](#) page. You can configure more device settings here, you can enable [Video Encryption](#) to protect photos and videos with password, check [firmware update](#) for your device, set the system time zone, and [remove device](#) from the network.

